



MPEX
MULTI-PURPOSE
SPINNAKER FABRICS



BAINBRIDGE
INTERNATIONAL

www.bainbridgeint.com

Technical Innovation and Service - The Fabric of Our Business

Introduction

Introduction

Introduction

With a full range of sailcloth, sailmakers' hardware and a global sales network, Bainbridge is uniquely qualified and committed to supplying the finest quality materials.

Founded in 1917, Bainbridge International is one of the longest established sailcloth manufacturers in the world, with almost a century's experience in developing and supplying the highest quality, highest performance materials to the marine industry.

Bainbridge has always been at the forefront of technical developments within the world of sailcloth. Through the skills of our technical team, we have developed a number of products including AIRX Performance Spinnaker Fabrics, Ocean Woven Fabrics, DIAX Laminated Sailcloth, Membrane Sails and Sailman Full Batten Systems. These have been used by many high profile campaigns over the years.

We supply a diverse range of products to many industries through our sales locations in Southampton, UK and in Massachusetts and California in the USA. Our trained and experienced sales staff, supported by our network of global distributors, service customers in over 80 countries and are backed by well stocked warehouse facilities able to efficiently meet the needs of our customers.

Our dedication to product development, coupled with our commitment to providing quality and innovation is what has made Bainbridge a market leading organisation for almost 100 years.

Order Online at www.bainbridgeint.com

By logging on to www.bainbridgeint.com you can browse our online catalogue and trade e-commerce site, view live stock availability and up to the minute pricing. The products shown on our website also appear in our catalogues, however as we introduce new products, these appear first on the website.

By using your unique and secure login details, you can place orders directly, reserve stock for quick delivery and benefit from emailed order confirmation.

MPEX

MPEX Multi-Purpose Spinnaker Fabrics

The MPEX Range

The new MPEX range of multi-purpose nylon spinnaker fabrics have been designed specifically for cruise and club race applications. They are the result of a comprehensive development process involving intensive design, testing and investment. They are manufactured using the same technology as AIRX but with greater emphasis on durability and value over ultimate performance.

The project objective was to deliver the cruising sailor with marketing leading spinnaker fabrics at the most popular weights that can produce stronger, faster and above all, longer lasting sails that are excellent value for money.

AIRX Pedigree

The MPEX range was the same team of Bainbridge fabric engineers that developed AIRX, the product that has redefined racing spinnaker fabrics and delivered projects such as America's Cup and Volvo teams uncompromised performance.

Quality Yarn

Selecting the right fibre was key to the MPEX project. Only precisely the right yarn could deliver a product that could meet the demanding design specification.

Tried and Tested

The new MPEX range has been exhaustively tested. In the lab, durability and performance tests were carried out and on the water, hundreds of sailing hours of test data was collected and analysed to ensure all styles deliver the strength, performance, durability and value sought after by cruising and club racing sailors worldwide.

MPEX-70

MPEX Multi-Purpose Spinnaker Fabrics

MPEX-70 Specifications

| Style | Construction: Warp x Fill | Ripstop: mm | Width: mm/in | Weight: gsm/smoz |
|---------|------------------------------|----------------|-----------------|---------------------|
| MPEX-70 | 40 x 40 | 6.5 x 6.5 | 1520 / 60 | 48 / 1.12 |

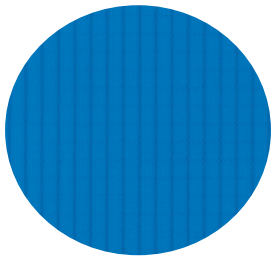
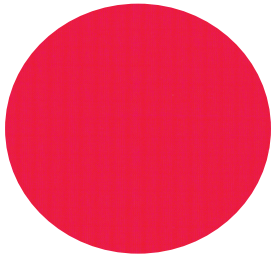

MPEX-70



www.bainbridgeint.com

MPEX
MULTI-PURPOSE
SPINNAKER FABRICS

MPEX-90

MPEX Multi-Purpose Spinnaker Fabrics

MPEX-90 Specifications

| Style | Construction: Warp x Fill | Ripstop: mm | Width: mm/in | Weight: gsm/smoz |
|---------|------------------------------|----------------|-----------------|---------------------|
| MPEX-90 | 70 x 70 | 7 x 7 | 1520 / 60 | 68 / 1.59 |

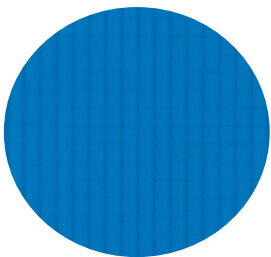
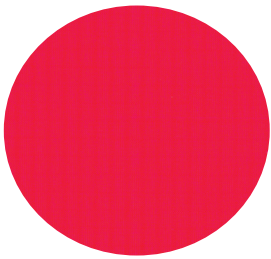

MPEX-90



MPEX-110

MPEX Multi-Purpose Spinnaker Fabrics

MPEX-110 Specifications

| Style | Construction: Warp x Fill | Ripstop: mm | Width: mm/in | Weight: gsm/smoz |
|----------|------------------------------|----------------|-----------------|---------------------|
| MPEX-110 | 140 x 140 | 7 x 7 | 1520 / 60 | 110 / 2.57 |



MPEX-110



www.bainbridgeint.com

MPEX
MULTI-PURPOSE
SPINNAKER FABRICS

MPEX-130

MPEX Multi-Purpose Spinnaker Fabrics

MPEX-130 Specifications

| Style | Construction: Warp x Fill | Ripstop: mm | Width: mm/in | Weight: gsm/smoz |
|----------|------------------------------|----------------|-----------------|---------------------|
| MPEX-130 | 210 x 210 | 7 x 7 | 1520 / 60 | 130 / 3.04 |



MPEX-130



MPEX-150

MPEX Multi-Purpose Spinnaker Fabrics

MPEX-150 Specifications

| Style | Construction: Warp x Fill | Ripstop: mm | Width: mm/in | Weight: gsm/smoz |
|----------|------------------------------|----------------|-----------------|---------------------|
| MPEX-150 | 210 x 210 | 7 x 7 | 1520 / 60 | 150 / 3.50 |



MPEX-150



www.bainbridgeint.com

MPEX
MULTI-PURPOSE
SPINNAKER FABRICS

Bainbridge International Ltd.

8 Flanders Park
Hedge End
Southampton
Hampshire
SO30 2FZ
England

Tel: +44 (0)1489 776010

Fax: +44 (0)1489 776015

email: info@bainbridgeint.co.uk

Bainbridge International Inc.

255 Revere Street
Canton
Massachusetts
02021
USA

Tel: +1 781 821 2600

Fax: +1 781 821 2609

email: info@bainbridgeint.com

Bainbridge International Inc.

15242 Transistor Lane
Huntington Beach
California
92649-1142
USA

Tel: +1 714 373 3322

Fax: +1 714 373 3326

email: info@bainbridgeint.com

Bainbridge International Pty. Ltd.

273 Harbord Road
PO Box 254
Brookvale
NSW 2100
Australia

Tel: +61 (0)2 9938 1788

Toll Free: +61 18 0073 1149

Fax: +61 (0)2 9938 2459

email: info@bainbridgeint.com.au

Bainbridge International France

UniSails SARL
5 rue Marius Berliet
PA de la Biliais Deniaud
44360 Vigneux de Bretagne
France / Spain

Tel: +33 (0)2 51 13 05 40

Fax: +33 (0)2 51 13 04 56

email: info@bainbridgeint.fr

BB Technics Oy

Sinikalliontie 18 B
FIN-02630 Espoo
Finland

Tel: +358 103 098 560

Fax: +358 103 098 565

email: stefan.kevin@bangbonsomer.fi

Q.C.D Limited

8 Taylors Road
Sandringham
Auckland 1025
New Zealand

Tel: +64 (0) 9 366 7118

Fax +64 (0) 9 366 7119

email: sales@qcd.co.nz

On Deck BV

Leimuiderdijk 478a
2156 MX Weteringbrug
Holland

Tel: +31 (0)71 3313366

Fax: +31 (0)71 3313387

email: allhands@on-deck.nl

Fordewind-Regatta Ltd

Petrovskaya Kosa 7
197110 St. Petersburg
Russia

Tel: +7 812 327 4580

Fax +7 812 327 4581

email: alexey.rusetsky@fordewind.spb.ru

Columbus Marine A/S

Svejsegangen 3
Karlslunde
Denmark

Tel: +45 4619 1166

Fax: +45 4619 1353

email: columbus@columbus-marine.dk

Takis Kokkotas Co. Ltd.

80 Mezonos Str
104 38 Athens

Greece / Bulgaria / Romania / Croatia

Tel: +30 210 52 28 540

+30 210 52 25 897

Fax +30 210 5247225

email: info@kokkotas.gr

Asperö Handels AB

PO Box 5009
Traneredsvägen 112
SE-426 05 V. Frölunda
Sweden / Norway

Tel: +46 31 299 190

Fax +46 31 691 965

email: info@aspero.se

Herman Gotthardt GmbH

Leunastrasse 50
D-22761 Hamburg
Germany

Tel: +49 40 85150550

Fax: +49 40 8509133

email: info@gotthardt-yacht.de

Boat Rigging s.r.l

Via San Gallo 23
Tavernelle Val di Pesa Loc. Sambuca (FI)
Italy / Croatia

Tel: +39 055 8071964

Fax: +39 055 8091541

email: luca@boatrigging.it

Sacloma S.a.s

Via Cisa Sud 125
19037 S.Stefano di Magra (SP)
Italy

Tel: +39 0187 630603

Fax: +39 0187 633264

email: sacloma@sacloma.com



www.bainbridgeint.com

Technical Innovation and Service - The Fabric of Our Business